

# FLOS

F0391033 Anthracite

## Almendra Linear Suspension 3 Primer NEW

Designed by Patricia Urquiola, 2022

45W - 1353lm - 2700K - CRI> 95

Suspension lamp with diffused light emission available in linear and organic compositions. Tubular structure made of aluminium and CNC aluminium terminals with matte or metallized finish. Edge Lighting technology integrated. Light units can be turned by steps of 60° within the structure in order to change the direction of the light emitted. Metal rosette with primer finish. The integrated electronics in the ceiling rose allow the use of different dimming systems: 1-10V, DALI, push-dim or potentiometer. Useful length of the cable 3 mt. The product has been designed according to the ISCC standards and it is assembled with total absence of glued components so that it can be completely separated for future recyclability.

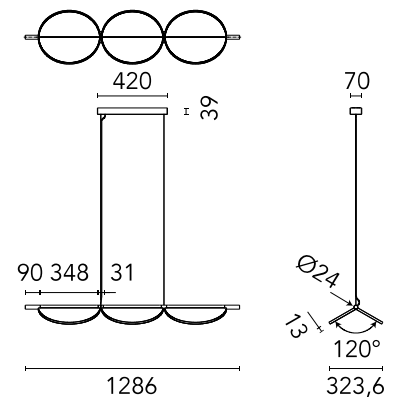

Are you a professional and your project needs consulting and support?

[BOOK AN APPOINTMENT](#)

### Main specifications

EAN	8059607044940
Mounting	Suspension
Environments	Indoor dry location
Light Source Type	LED
LED type	Edge Lighting
Power (W)	45
System flux (lm)	1353

### Physical

Colour	Anthracite
Length (mm)	1286
Cord length (mm)	2800
Net weight (kg)	7.14
Package volume (m3)	0.15
IP internal	20

### Download

[Mounting instructions](#)  PDF

### Photometric Files

[LDT / IES](#)  LDT

### Technical Drawings

[2D](#)  ZIP

[3D](#)  ZIP

[Bim](#)  ZIP



## Schematic light drawing

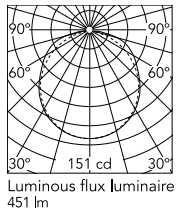

## Photometric

Lighting type	Direct
Light distribution	Symmetric
CCT (K)	2700
CRI>	95

## Electrical

Insulation class	I
Frequency (Hz)	50/60
Main voltage (Vac)	220-240
LED voltage Vf (Vdc)	null
Driver	Integrated
Dimmable	Yes
Dimming type	Dimmable 0-10V, Dimmable Push, Dimmable 1-10V, Dimmable DALI 1
Dimming interface	Remote Dimmable (Dimmer Not Included)

## Ecodesign and Energy Labelling

This product contains a light source of energy efficiency class E



Non-replaceable light source

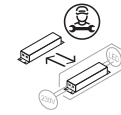

Replaceable control gear by a professional

## Spare Parts

