



ZEFIRO OUTDOOR *ANTONIO CITTERIO* **2019**

TABLES

ZEFIRO OUTDOOR | ANTONIO CITTERIO | 2019

TABLE

Structure in metal and aluminum with epoxy powder-coat finish in the following colors: white 100, wine red 405, khaki green 705, burnished, matt titanium 710; or with embossed lacquered finish in white 300, sand 310, brick 320, sage green 330, terracotta 325, forest green 335, charcoal 350. Rests on tips made of thermoplastic material. Upon request, aluminum tips for use on soft surfaces

Top in the following types of stone: lava stone, porphyry, pietra del cardoso, beola argentata

Top for codes 238L1, 238L2, 238L3, 238L4, 238M1, 238M3, 238M5, 238M6, 238M7, 238M8 in solid iroko with natural, stained grey, stained brown, lacquered white finish

Cover in waterproof material; cover is upon request, with upcharge

COD. 0238L1 TABLE WOODEN TOP

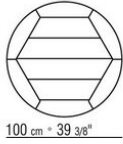
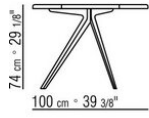

COD. 0238L2 TABLE WOODEN TOP

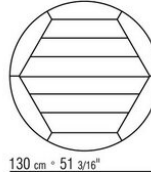
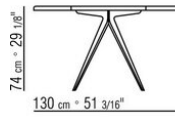

COD. 0238L3 TABLE WOODEN TOP

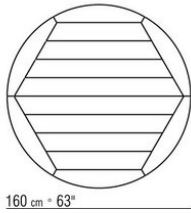
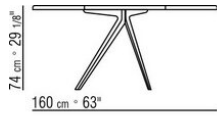

COD. 0238L4 TABLE WOODEN TOP

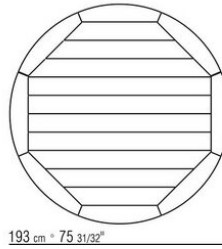
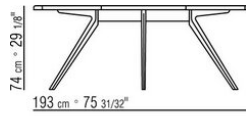

COD. 0238M1 TABLE WOODEN TOP

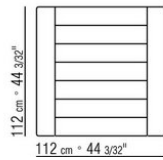
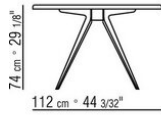

COD. 0238M3 TABLE WOODEN TOP

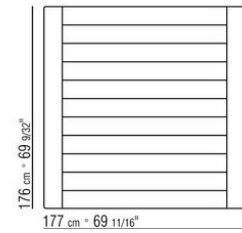
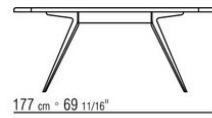
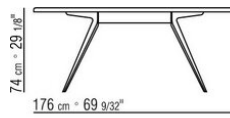

COD. 0238M5 TABLE WOODEN TOP

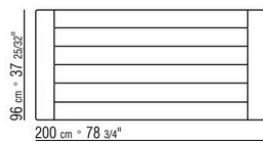
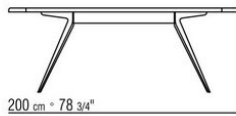
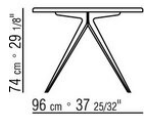

COD. 0238M6 TABLE WOODEN TOP

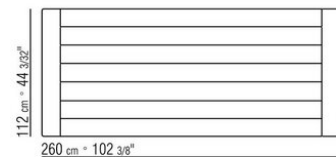
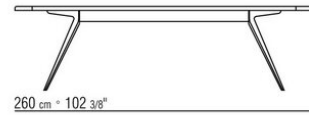
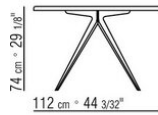

COD. 0238M7 TABLE WOODEN TOP

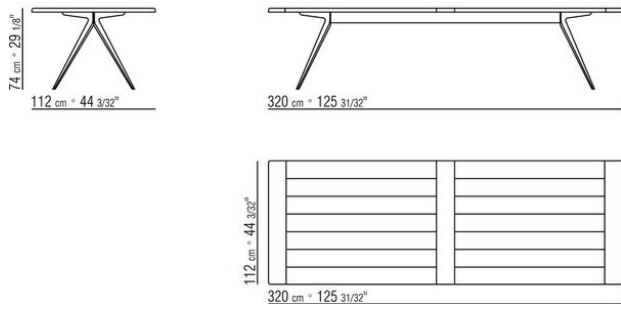

COD. 0238M8 TABLE WOODEN TOP

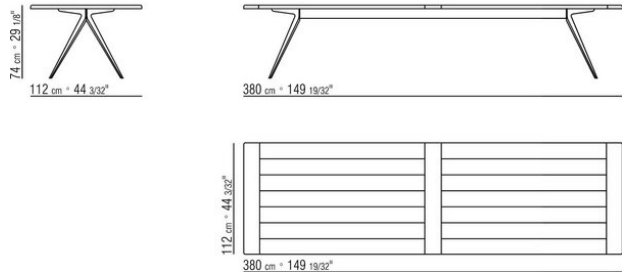

COD. 0238L5 TABLE

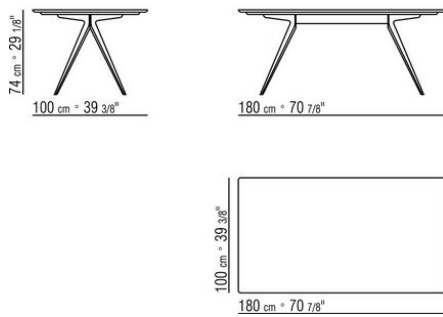

COD. 0238L6 TABLE

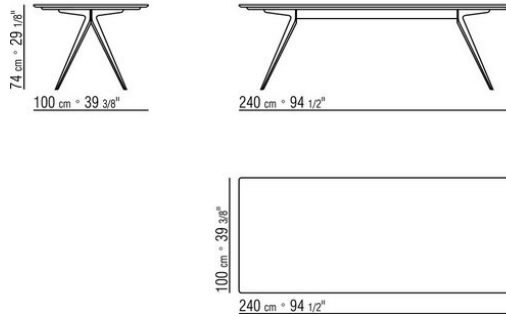

COD. 0238L7 TABLE

