Bend-Sofa

SOFAS

Patricia Urquiola



Description

It conveys the impression of having been moulded by an artist but actually derives from a study of 3D models and digital research. It seems a monolith that has been shaped by subtraction, rounded and moulded by the designer. The irregular shape enhances comfort, the contrasting seams define the design and movement. Bend Sofa combines manual skills and technology, solidity and strength, along with considerable flexibility in terms of use ensured by the extensive range of models. The distinctive originality of Bend-Sofa is combined with a detailed compositional study. The corrugated modules whose assembly starts with the seating, ottoman and corner elements allow a broad range of possible solutions - from linear versions in compact sizes for use in areas with limited space, to layouts that are complex and far-ranging.

Technical information

Internal frame:

tubular steel and steel profiles

Internal frame upholstery:

Bayfit® (Bayer®) flexible cold shaped polyurethane foam, polyester fibre cover

Back cushion (B40C-B55C):

upholstery : down feather + polyurethane insert, typology : box style, stitchings : zig zag

Support (BS-BSB):

visco-elastic polyurethane, polyester and cotton fibre cover

Feet:

black colour thermoplastic material

Cover:

fabric or leather (zig zag stitchings)

Technical drawings

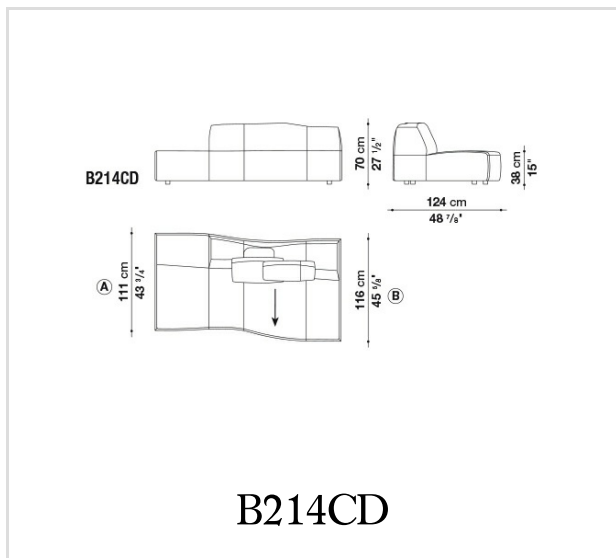
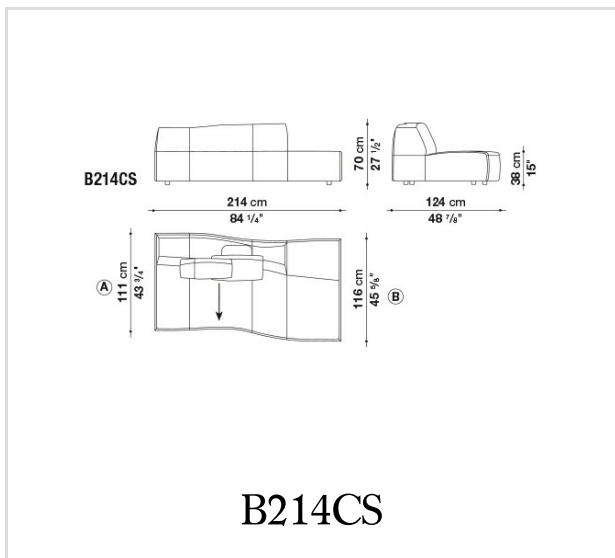
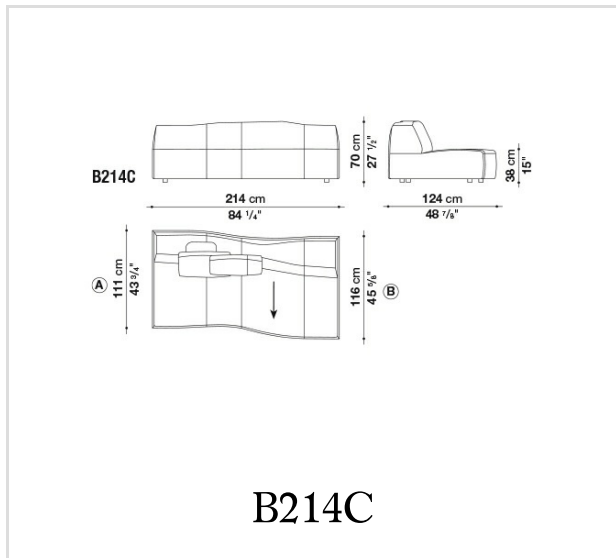
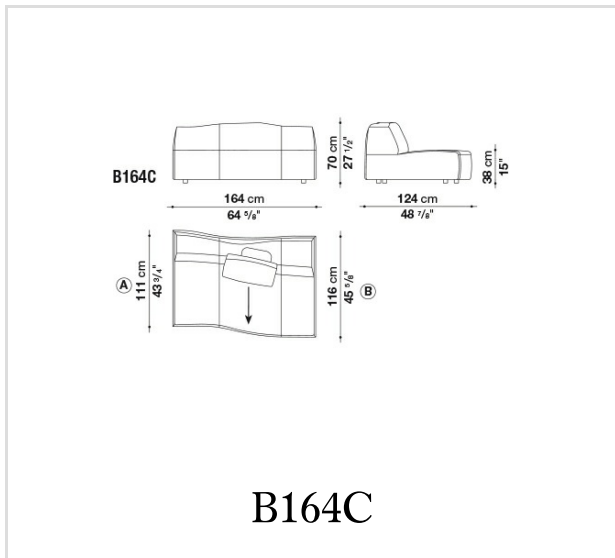

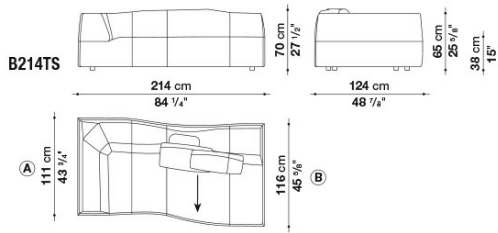

B214TS

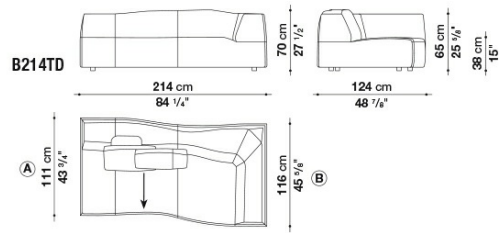

B214TD

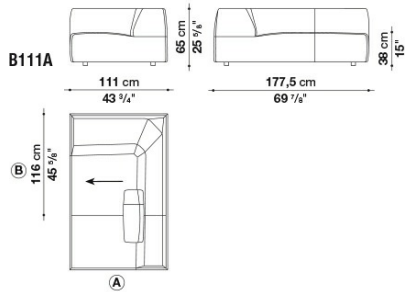

B111A

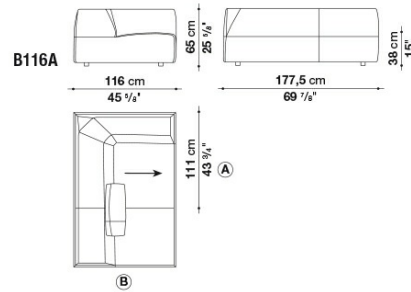

B116A

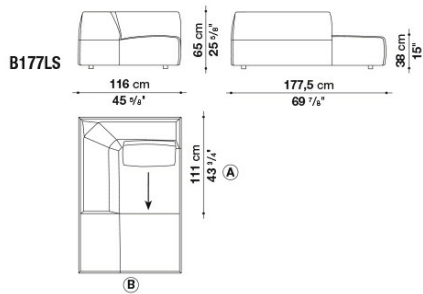

B177LS

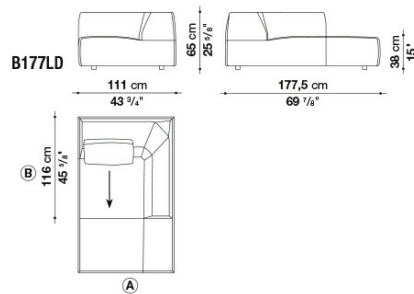

B177LD

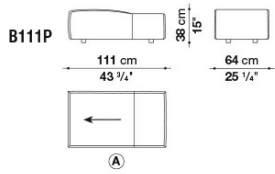

B111P

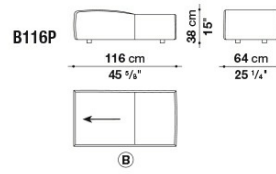

B116P

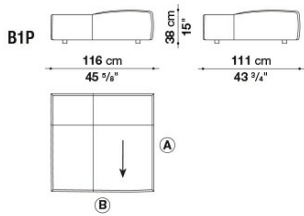

B1P

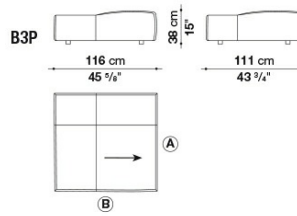

B3P

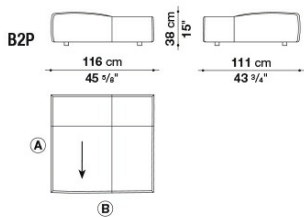

B2P

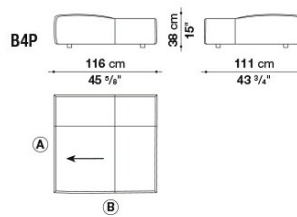

B4P

Compositions

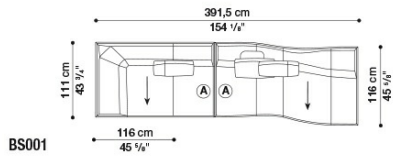

BS001

01

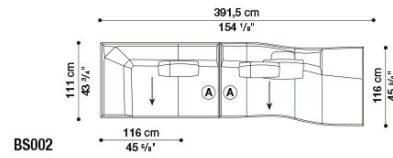

BS002

02

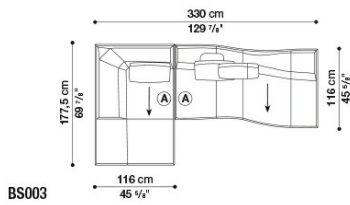

BS003

03

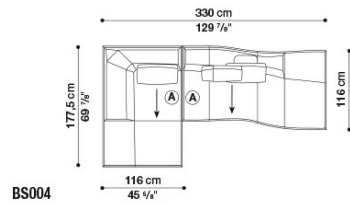

BS004

04

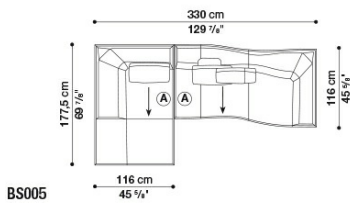

BS005

05

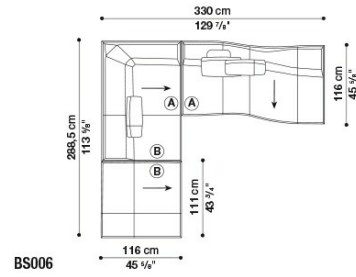

BS006

06

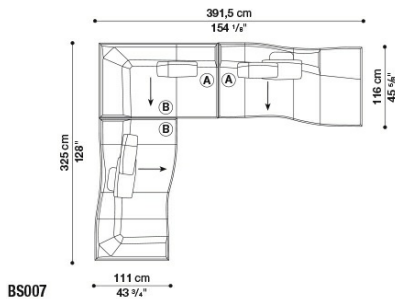

BS007

07

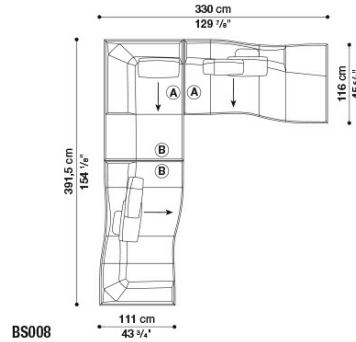

BS008

08

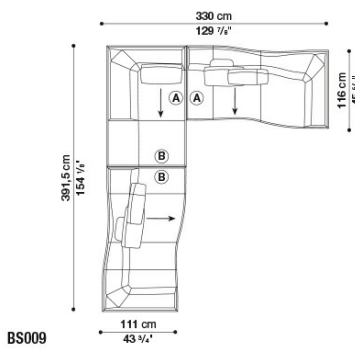

BS009

09

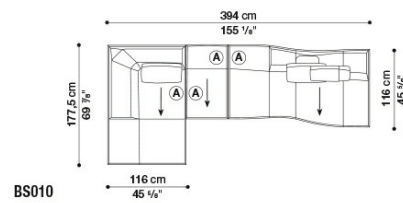

BS010

10

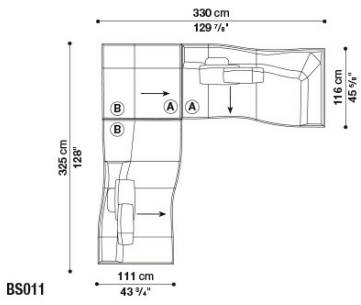

BS011

11

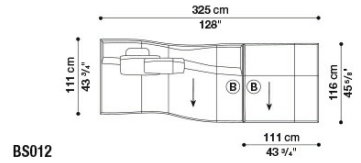

BS012

12

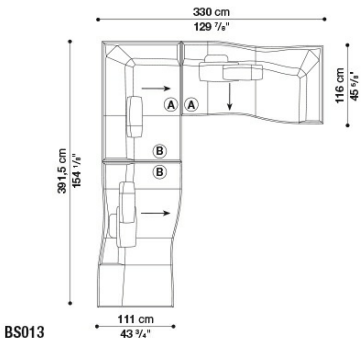

BS013

13

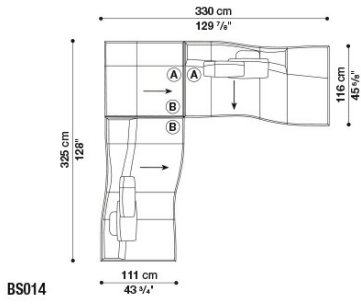

BS014

14

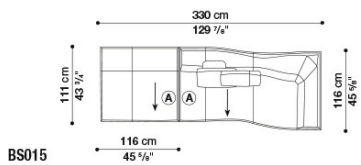

BS015

15

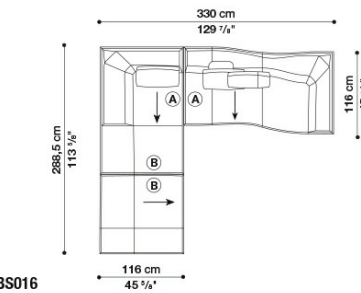

BS016

16

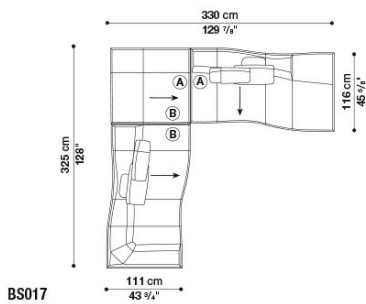

BS017

17

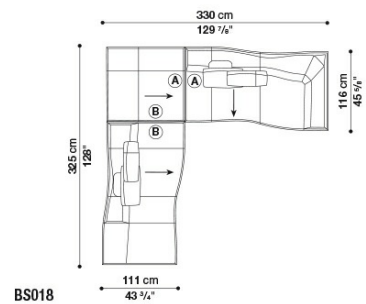

BS018

18

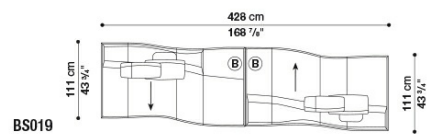

BS019

19

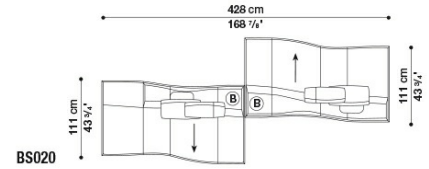

BS020

20

B&B Italia reserves the right to make technological and aesthetic improvements to its models, including changes to the sizes and materials, without notice. The technical drawings do not define the details of the product. The measurements shown are indicative and may undergo changes. In particular, the dimensions relevant to the padded parts are subject to usage tolerances over time caused by the normal adjustment of the padding. For the specific information, please contact the dealer closest to you.