

Approved to UL standards by CSA

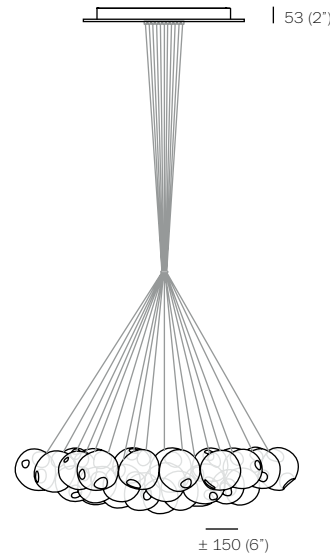

3000
(10')
standard
max.

Overall drop
provided by
client

36500
(120')
custom
max.

min.
drop length
1300mm (51')

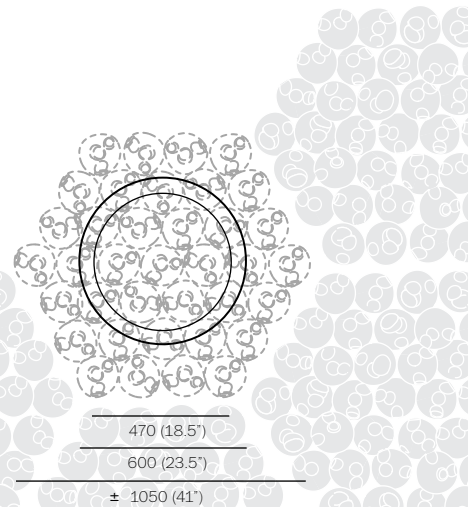

approx 71.5kg (157lb)

28 is an exploration of fabrication process which is part of Arbel's quest for specificity in manufacturing. Instead of designing form itself, here the intent was to design a system that produces form. Arbel developed a method that has loose parameters built into it which produce a different shape in every iteration of the fabrication procedure. Thus, every 28 made is formally different from any other 28 in existence.

Individual 28 pendants result from a complex glass blowing technique whereby air pressure is intermittently introduced into and then removed from a glass matrix which is intermittently heated and then rapidly cooled. The result is a distorted spherical shape with a composed collection of inner shapes, one of which is made of opaque milk glass and houses a low voltage (12V, 20W) xenon.

28 pendants are designed to cluster in hexagonal shapes which nestle into each other to create patterns as dictated by the needs of the interior. They may also be clustered or composed in an ambient manner similar to their distant cousins the 14's.

Standard 28's are made with clear glass exterior spheres and milk white interior glass cavities. Custom 28's are possible with infinite versatility in colour compositions, sizes and shapes.

APPLICATIONS

Suitable for residential and commercial use. CSA, CE approved; approved to UL standard by CSA. Popular applications to date include clusters over tables in residential dining rooms and restaurants, accessory lighting in living rooms, decorative lighting, linear configurations or clusters over bars and kitchen islands, and large chandeliers in building lobbies and other public spaces.

MATERIALS

Blown glass, braided metal coaxial cable, electrical components and a white powder coated canopy.

Note: Preset pendant lengths may have a variance of $\pm 50\text{mm}$ (2")

Note: As an alternative to a built-in transformer, Bocci recommends mounting transformers remotely in an easily accessible and hidden location for ease of long-term maintenance.

Purchase replacement lamps online at www.bocci.ca/lamps

Unless otherwise noted when ordering, all chandeliers will be outfitted to be xenon compatible.

Worldwide patents issued and pending
Made in Vancouver, Canada

For additional information, please contact:

BOCCI Vancouver
info@bocci.ca
www.bocci.ca

BOCCI Berlin
infoeu@bocci.ca
www.bocci.ca

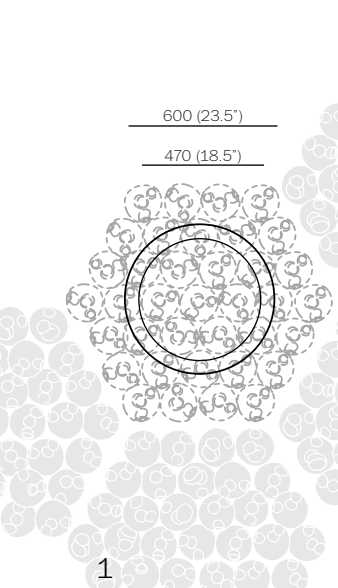

1

Measure and mark out the chandelier canopy position on the ceiling.

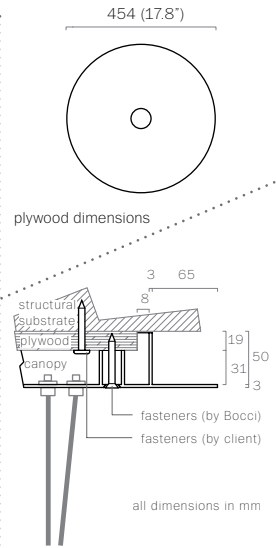

2

Note: The client is responsible for providing a robust 3/4" (19mm) plywood backing or wood blocking to securely anchor to the structural substrate.

Connections from the plywood to the structural substrate are the client's responsibility. Measure the plywood so that it fits within the canopy side walls (refer to detail above).

Anchor the plywood backing to the structural ceiling substrate.

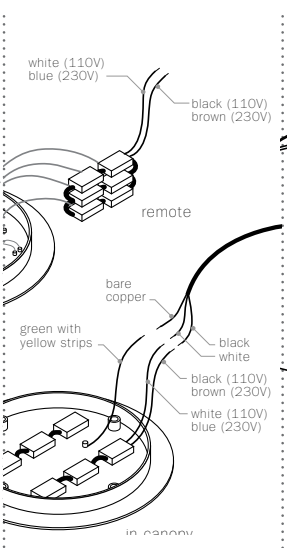

3

Connect transformers inside the canopy to line voltage, ensuring to match black wire to black wire and white to white. For the ground connection, connect the green wire with yellow stripe to the bare copper wire or green wire in the junction box.

Note: As an option, Bocci recommends mounting transformers remotely in a close by, accessible and hidden location for ease of long term maintenance. Installation to be done by certified personnel to ensure code compliance.

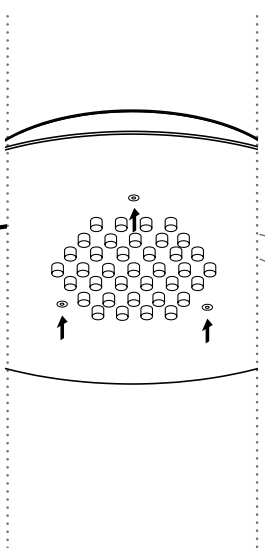

4

Anchor canopy into the plywood backing using the fasteners provided.

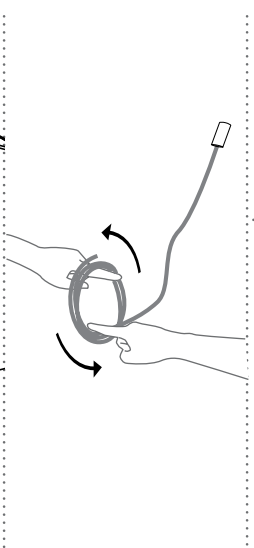

5

Very carefully uncoil the braided coaxial cable in a spool like manner. Insert your index fingers into opposite sides of the roll then rotate your fingers around each other to unroll the coaxial cable.

Use patience: allow the cable to uncoil completely to avoid kinks.

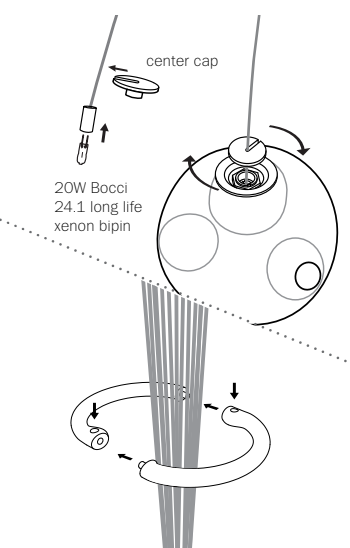

6

Each pendant terminates in a "headphone jack" type connector, which plugs into a receiving receptacle in the canopy. Plug in each pendant and turn the threaded sheathing into place by hand ensuring that it is adequately tightened. Tools are not required.

Bocci 24.1.2 long life bipin xenon lamps are included. Plug the lamp into the socket. Do not touch the lamp with your bare hands.

Remove the center cap from 28 pendant. Install 28 pendant by sliding the center cap onto the coaxial cable, gently insert the lamp into the pendant, then tighten the center cap connection by hand. Do not over tighten. Remove the protective film from the center cap after assembly.

Note: when using a dimmer for xenon use only low voltage electronic dimmer.

Prior to installing the ring around the coaxial cables, ensure that the pendants are composed in their intended hexagonal formation.

Gather the coaxial cables then install the ring with setscrews provided. Note: setscrews face up.

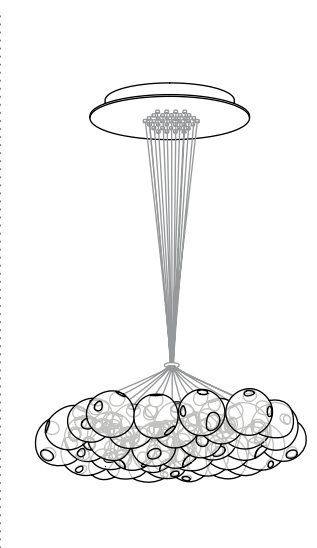

7

Adjust stainless steel ring to desired height.

Clean fingerprints from glass surfaces.

Turn fixture on.

* Purchase online for replacement lamps at www.bocci.ca/lamps

For additional assistance, please contact Bocci:

BOCCI Vancouver
info@bocci.ca
www.bocci.ca

BOCCI Berlin
infoeu@bocci.ca
www.bocci.ca

Worldwide patents issued and pending.

Made in Vancouver, Canada

Approved to UL standards by CSA



28.37

Design by Omer Arbel
INSTALLATION INSTRUCTIONS

© 2010, Bocci Design and Manufacturing Inc. All rights reserved. These drawings and the information contained herein may not be reproduced, communicated to the public, or made available in whole or in part without prior permission. Any inquiries should be directed to the following email address: admin@bocci.ca.